

Contact Details

Before using the product, please check the guide pages at the front of this catalog.

Internet

<https://www.daikinpmc.com/en/>

For latest information, PDF catalogs and operation manuals

Medium-pressure Cartridge Type Vane Pump

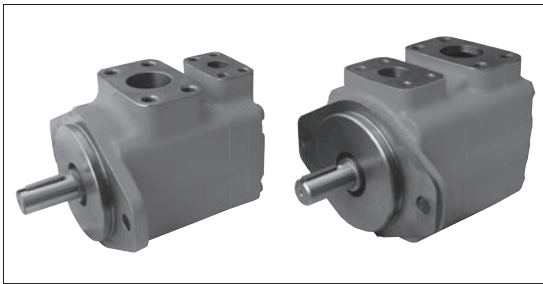

Features

- The intra-vane type structure realizes a low noise level at high pressure. The cartridge type design offers reliable operation over a prolonged period. These vane pumps with a maximum pressure of 20.6 MPa are suited to various applications in industrial machinery.

D
VANE PUMPS

Nomenclature

※ - DEV ※※ - ※ - ※ - ※ - 10
 1 2 3 4 5 6 7

1 Applicable fluid code

No designation: Wear-resistant hydraulic fluid
 Water-glycol hydraulic fluid
 F: Phosphate ester hydraulic fluid

2 Model No.

DEV: Medium-pressure cartridge type vane pump

3 Pump capacity code

20: DEV20 (7 to 45 cm³/rev)
 25: DEV25 (33 to 67 cm³/rev)
 35: DEV35 (81 to 121 cm³/rev)
 45: DEV45 (138 to 193 cm³/rev)

4 Pump capacity (cm³/rev)

DEV20	DEV25	DEV35	DEV45
2: 7	10: 33	25: 81	42: 138
5: 18	12: 40	30: 97	45: 147
8: 27	14: 45	35: 112	50: 162
9: 30	17: 55	38: 121	60: 193
11: 36	21: 67		
12: 40			
14: 45			

6 Installation types

No designation: Without foot
 B: With foot

Design No.

(The design No. is subject to

7 change)

5 Direction of rotation, when viewed from the shaft end

R: Clockwise (rightward)
 L: Counterclockwise (leftward)

Specifications and masses

Model No.	Displacement volume cm ³ /rev	Maximum pressure* MPa	Minimum pressure MPa	Minimum rotational speed min ⁻¹	Maximum rotational speed* min ⁻¹	Mass kg	
						Without foot support	With foot support
DEV20-2	7	13.8	0.7	600	1800	12.0	14.7
DEV20-5	18	20.6					
DEV20-8	27						
DEV20-9	30						
DEV20-11	36						
DEV20-12	40						
DEV20-14	45	13.8					
DEV25-10	33	17.2	0.7	600	1800	14.8	17.5
DEV25-12	40						
DEV25-14	45						
DEV25-17	55						
DEV25-21	67						
DEV35-25	81						
DEV35-30	97	17.2	0.7	600	1800	22.7	28.6
DEV35-35	112						
DEV35-38	121						
DEV45-42	138						
DEV45-45	147	17.2	0.7	600	1800	34.0	39.9
DEV45-50	162						
DEV45-60	193						

* Values with wear-resistant hydraulic fluid

- Foot supports are not provided with the pump. Order them separately as required by referring to Page S-2.
- Refer to Pages D-23 and 24 for the conditions of use for models compatible with flame-resistant hydraulic oil and for other notes on handling.
- Refer to Page S-5 for the machining dimensions of coupling holes.

Contact Details

Before using the product, please check the guide pages at the front of this catalog.

Internet

<https://www.daikinpmc.com/en/>

For latest information, PDF catalogs and operation manuals

External dimension diagram

DEV20

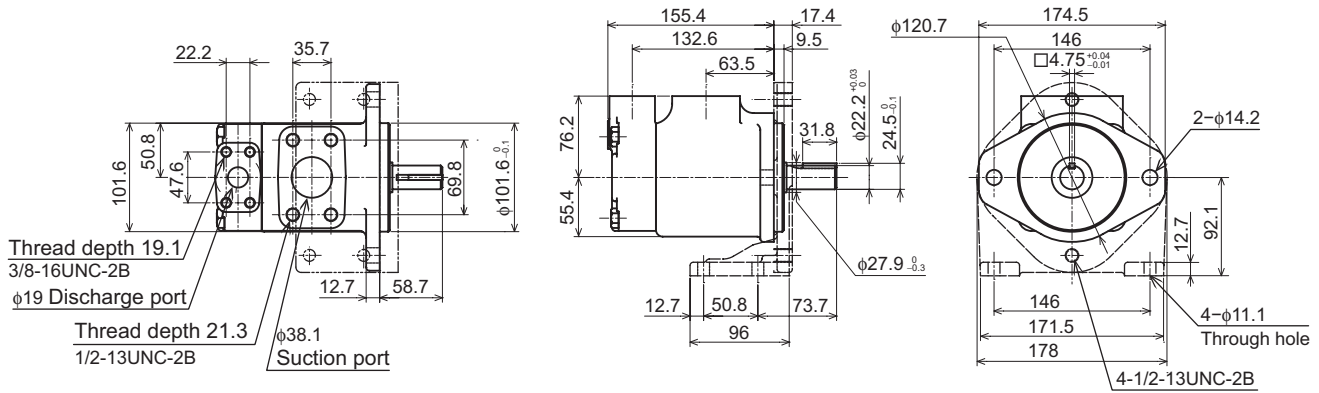

○ The foot mounting dimensions indicated in this drawing are those when foot model FTB-422583 is mounted.

DEV25, 35, 45

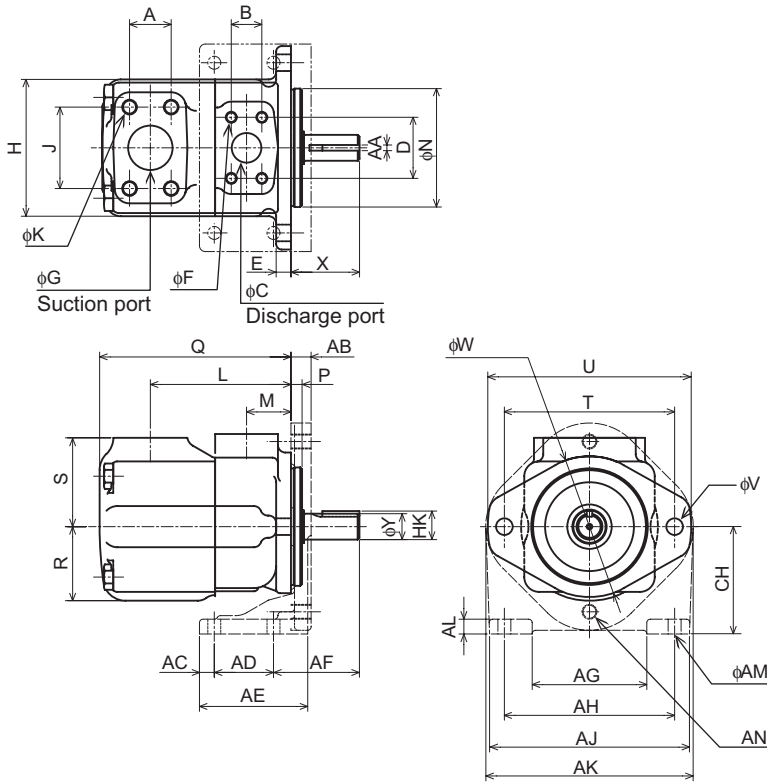

Model No.	φF	φK
DEV25	3/8-16UNC-2B Thread depth 19.1	1/2-13UNC-2B Thread depth 21.3
DEV35	7/16-14UNC-2B Thread depth 20.6	1/2-13UNC-2B Thread depth 23.9
DEV45	1/2-13UNC-2B Thread depth 23.9	5/8-11UNC-2B Thread depth 25.4

Model No.	DEV 25	DEV 35	DEV 45	Model No.	DEV 25	DEV 35	DEV 45
A	35.7	42.8	61.9	φY	22.2 ^{+0.03}	31.7 ^{+0.05}	31.7 ^{+0.05}
B	26.2	30.1	35.7	HK	24.5 ⁰ _{-0.1}	35 ^{+0.38} _{-0.1}	35 ^{+0.38} _{-0.1}
φC	25.4	31.8	38.1	AA	4.75 ^{+0.04} _{-0.01}	7.94 ^{+0.02} _{-0.03}	7.94 ^{+0.02} _{-0.03}
D	52.4	58.7	69.9	AB	12.7	19	19
E	12.7	15.7	16	AC	12.7	17.3	17.3
φG	38.1	50.8	76.2	AD	50.8	76.2	76.2
H	117	140	159	AE	96	131.6	131.6
J	69.9	77.7	106.3	AF	73.7	92.2	80.9
L	120.7	125.4	153.1	AG	98.3	164	164
M	38.1	38.1	42.9	AH	146	235	235
φN	101.6 ⁰ _{-0.1}	127 ⁰ _{-0.1}	127 ⁰ _{-0.1}	AJ	171.5	265	265
P	9.5	9.5	12.7	AK	178	213	213
Q	164	187	217	AL	12.7	15.7	15.7
R	63.5	69.8	82.6	φAM	11.1	17.3	17.3
S	76.2	82.6	93.6	AN	1/2-13UNC-2B thread	5/8-11UNC-2B thread	5/8-11UNC-2B thread
T	146	181	181	CH	92.1	109.5	109.5
U	175	213	213				
φV	14.2	17.5	17.5				
φW	120.7	147.6	147.6				
X	58.7	73.2	61.9				

○ The foot mounting dimensions indicated in this drawing are those when foot model FTB-422583 is mounted with DEV25, and those when foot model FTB-422584 is mounted with DEV35 / 45.

Contact Details

Before using the product, please check the guide pages at the front of this catalog.

Internet

<https://www.daikinpmc.com/en/>

For latest information, PDF catalogs and operation manuals

Sectional structural diagram

DEV20, 25, 35, 45

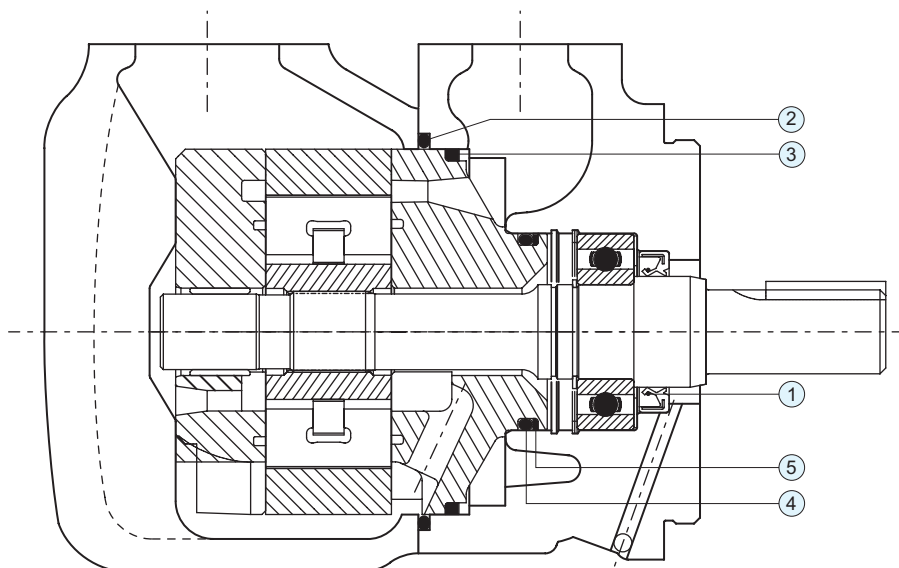

DEV20 Seal table

Part No.	Name	Quantity	Part specifications	Material
1	Oil seal	1	Special part	NBR
2	O-ring	1	AS568-236 (HS70°)	
3	Sealing ring	1	Special part	—
4	O-ring	1	AS568-222 (HS70°)	NBR
5	Backup ring	1	MS28774-222	PTFE

DEV25 Seal table

Part No.	Name	Quantity	Part specifications	Material
1	Oil seal	1	Special part	NBR
2	O-ring	1	AS568-241 (HS70°)	NBR
3	Sealing ring	1	Special part	—
4	O-ring	1	AS568-224 (HS70°)	NBR
5	Backup ring	1	MS28774-224	PTFE

DEV35 Seal table

Part No.	Name	Quantity	Part specifications	Material
1	Oil seal	1	Special part	NBR
2	O-ring	1	AS568-247 (HS70°)	NBR
3	Sealing ring	1	Special part	—
4	O-ring	1	AS568-230 (HS70°)	NBR
5	Backup ring	1	MS28744-146	PTFE

DEV45 Seal table

Part No.	Name	Quantity	Part specifications	Material
1	Oil seal	1	Special part	NBR
2	O-ring	1	AS568-253 (HS70°)	NBR
3	Sealing ring	1	Special part	—
4	O-ring	1	AS568-233 (HS70°)	NBR
5	Backup ring	1	MS28744-233	PTFE

General performance Fluid used: viscosity of 26 mm²/s, Fluid temperature: 50°C

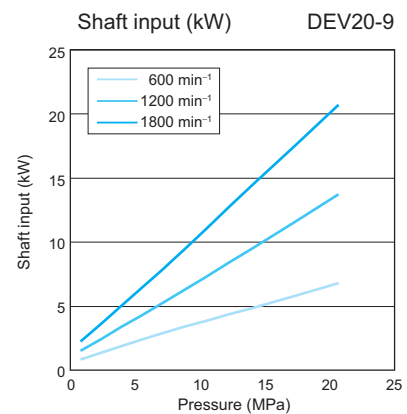
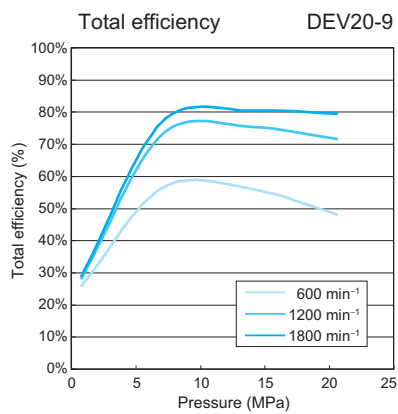
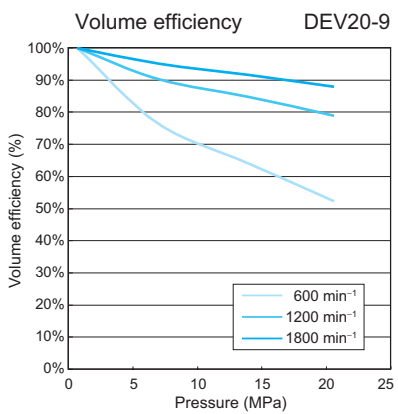
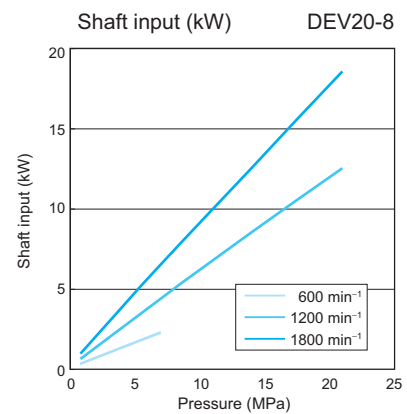
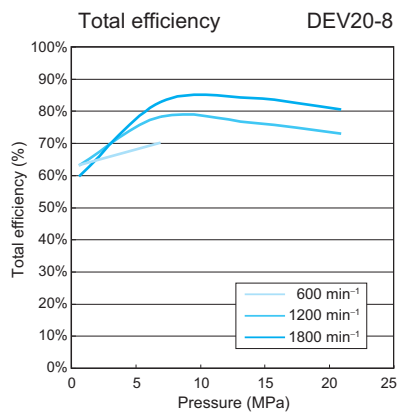
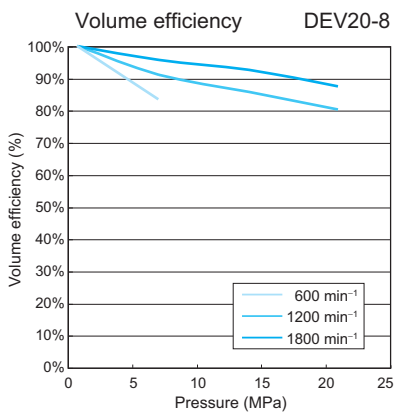
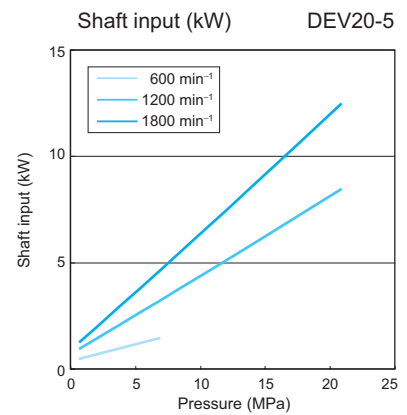
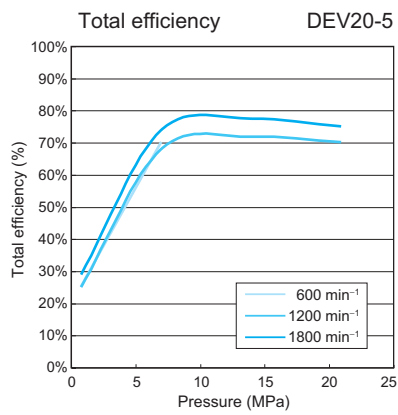
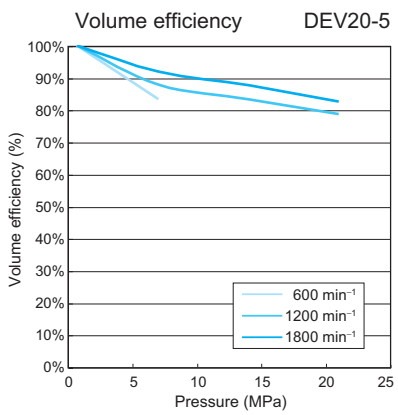
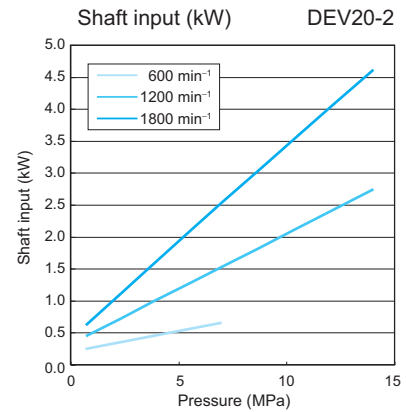
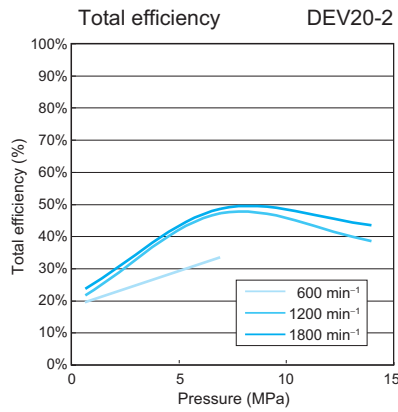
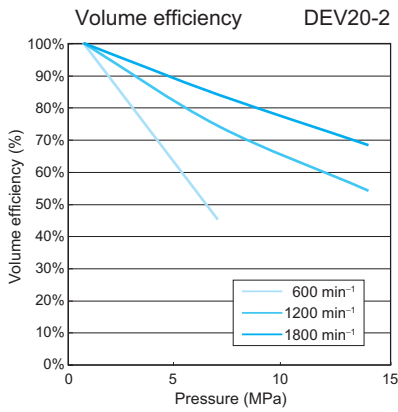

General performance Fluid used: viscosity of 26 mm²/s, Fluid temperature: 50°C

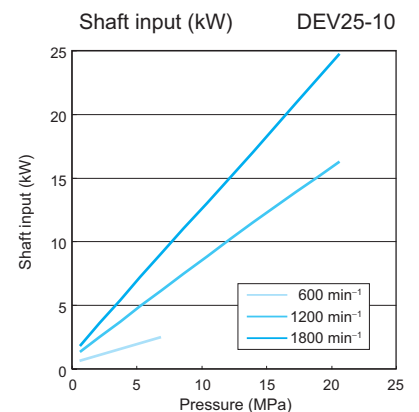
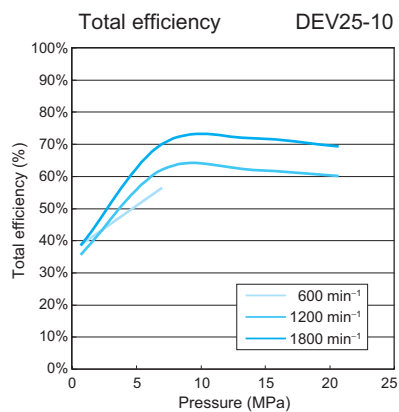
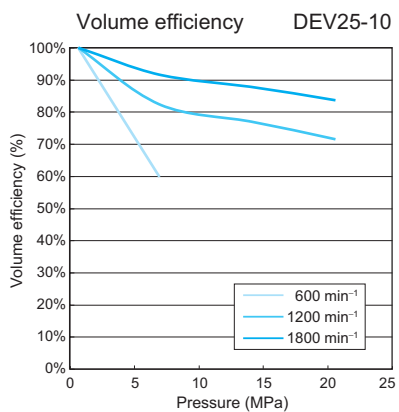
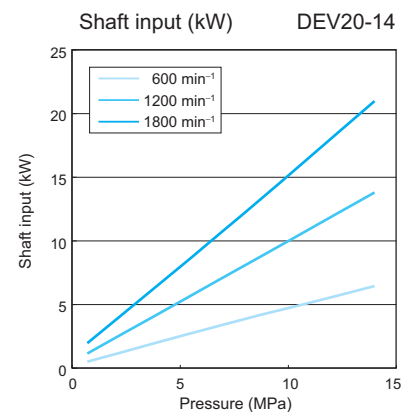
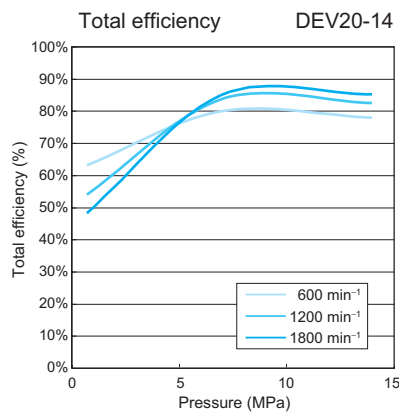
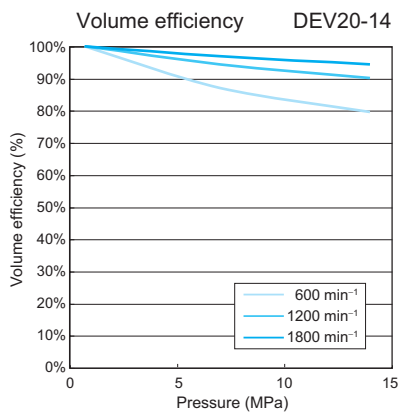
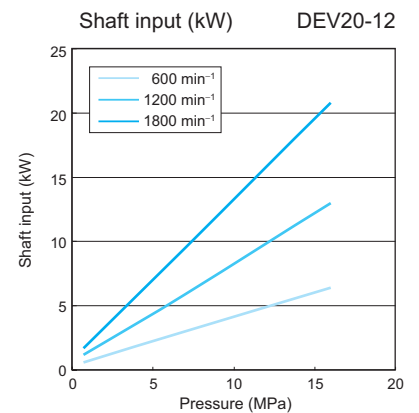
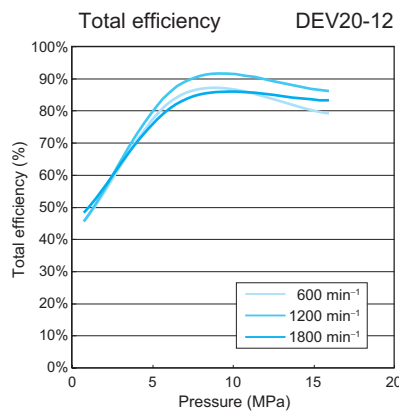
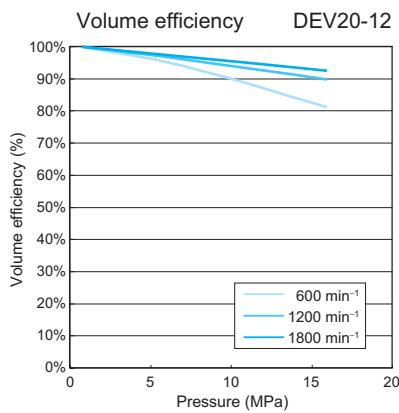
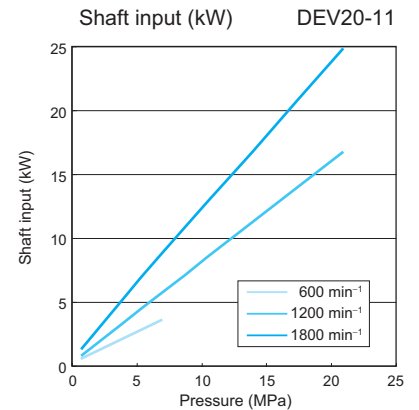
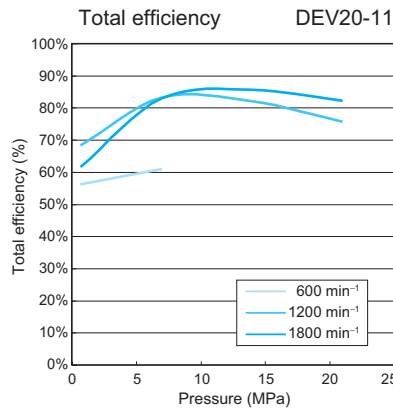
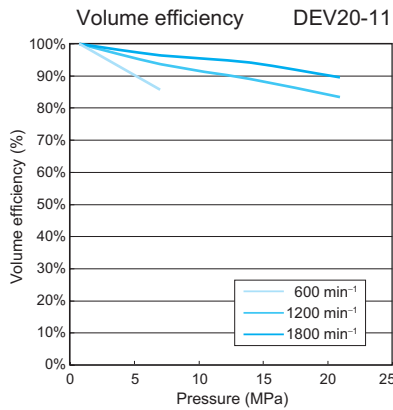

Contact Details

Before using the product, please check the guide pages at the front of this catalog.

Internet

<https://www.daikinpmc.com/en/>

For latest information, PDF catalogs and operation manuals

General performance Fluid used: viscosity of 26 mm²/s, Fluid temperature: 50°C

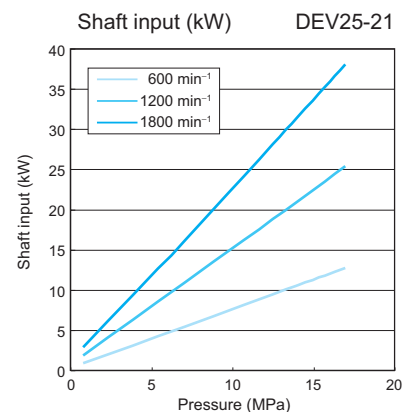
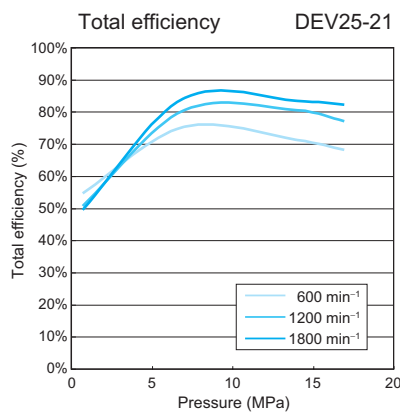
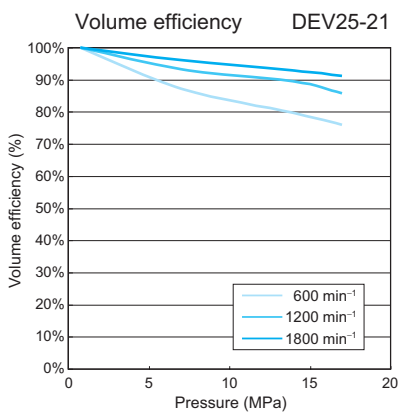
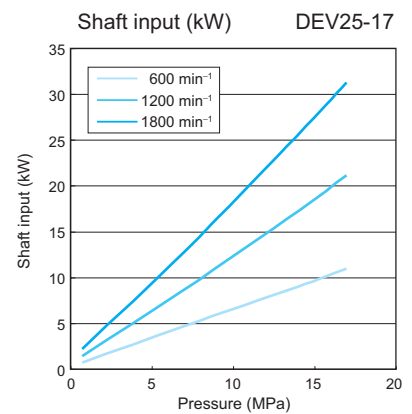
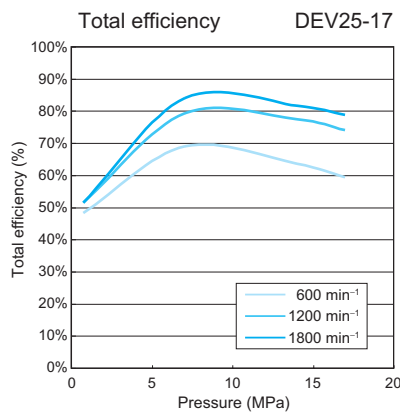
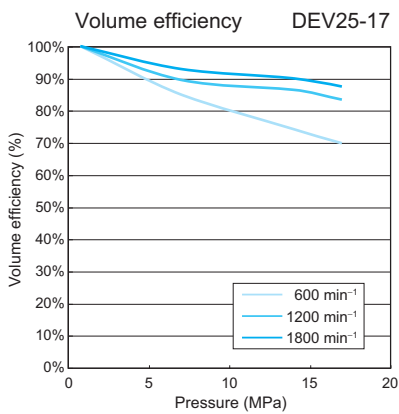
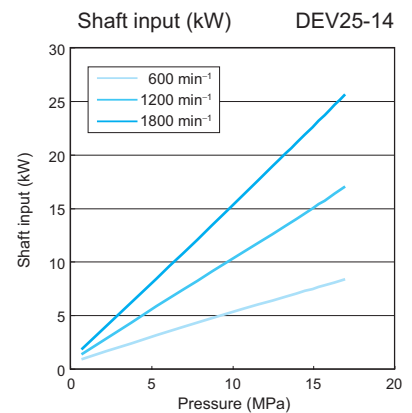
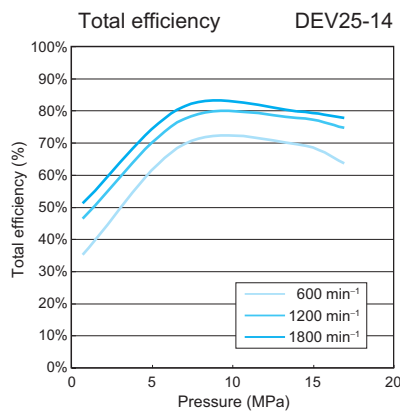
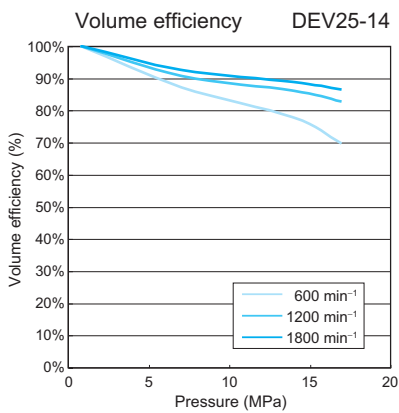
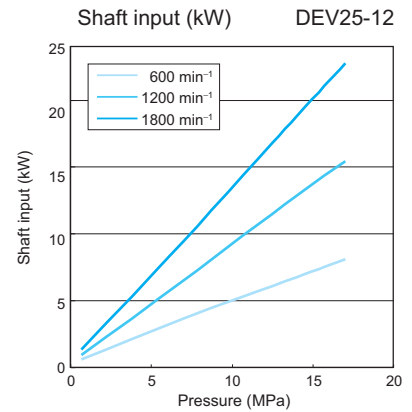
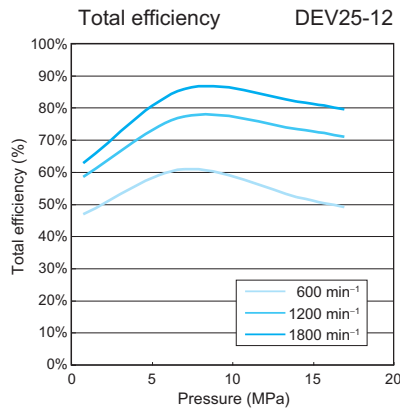
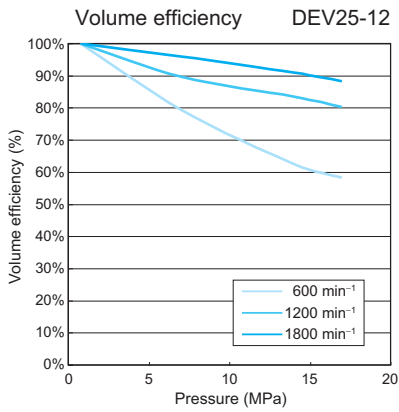

General performance Fluid used: viscosity of 26 mm²/s, Fluid temperature: 50°C

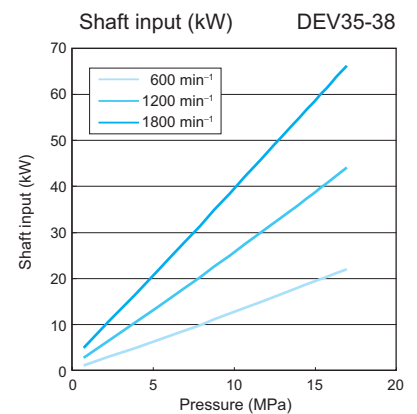
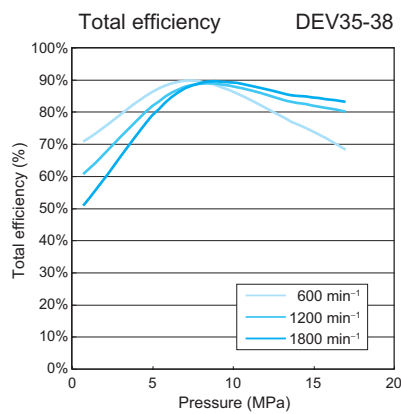
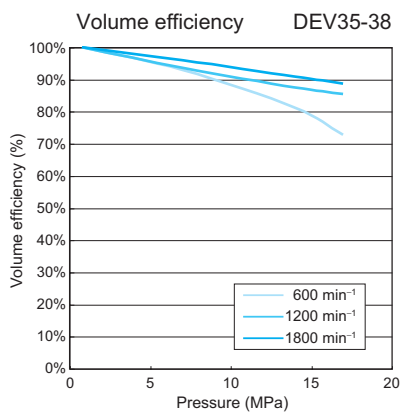
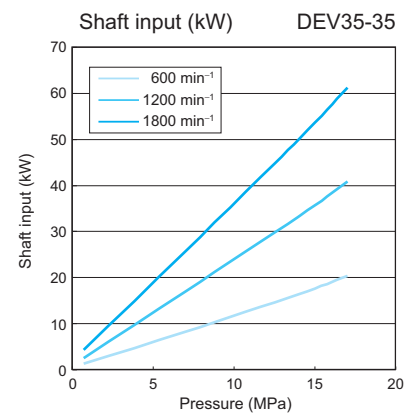
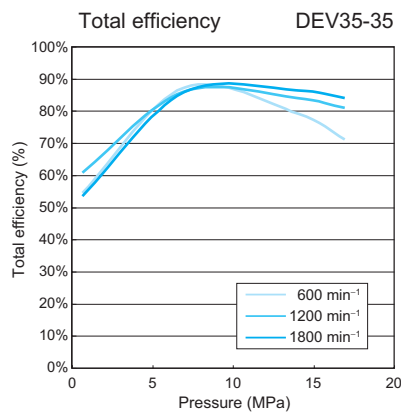
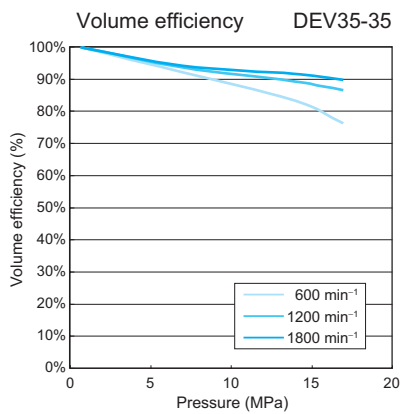
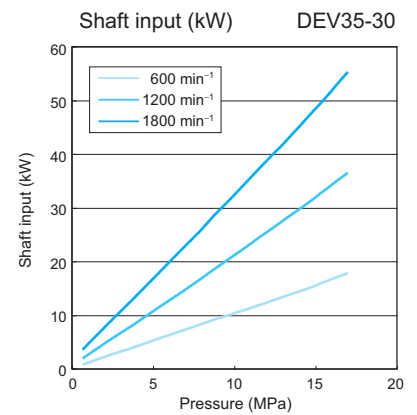
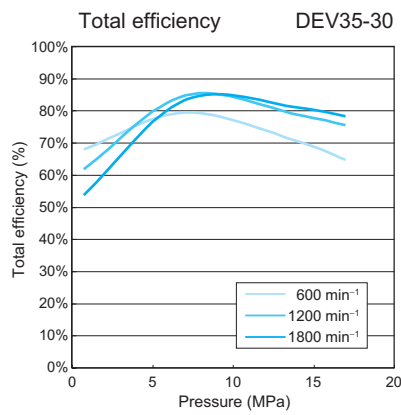
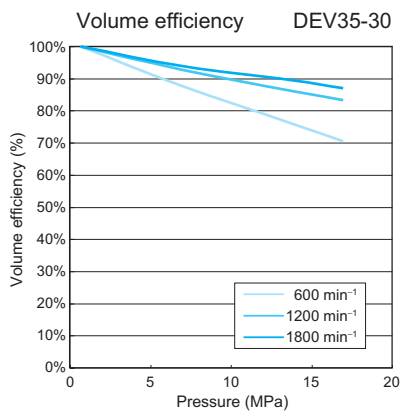
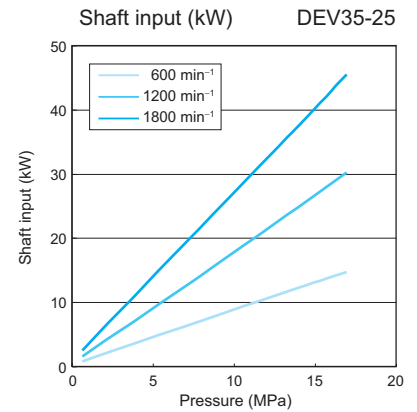
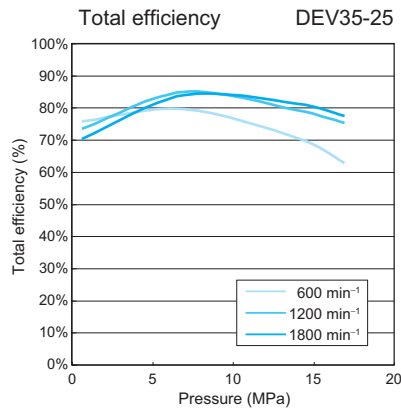
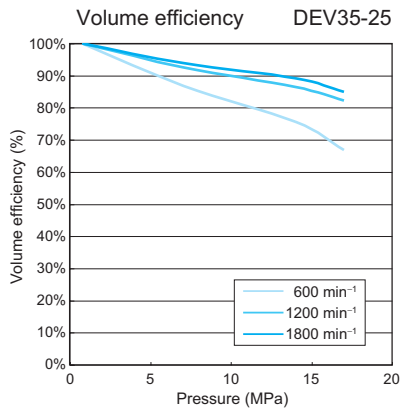

Contact Details

Before using the product, please check the guide pages at the front of this catalog.

Internet

<https://www.daikinpmc.com/en/>

For latest information, PDF catalogs and operation manuals

General performance Fluid used: viscosity of 26 mm²/s, Fluid temperature: 50°C

